

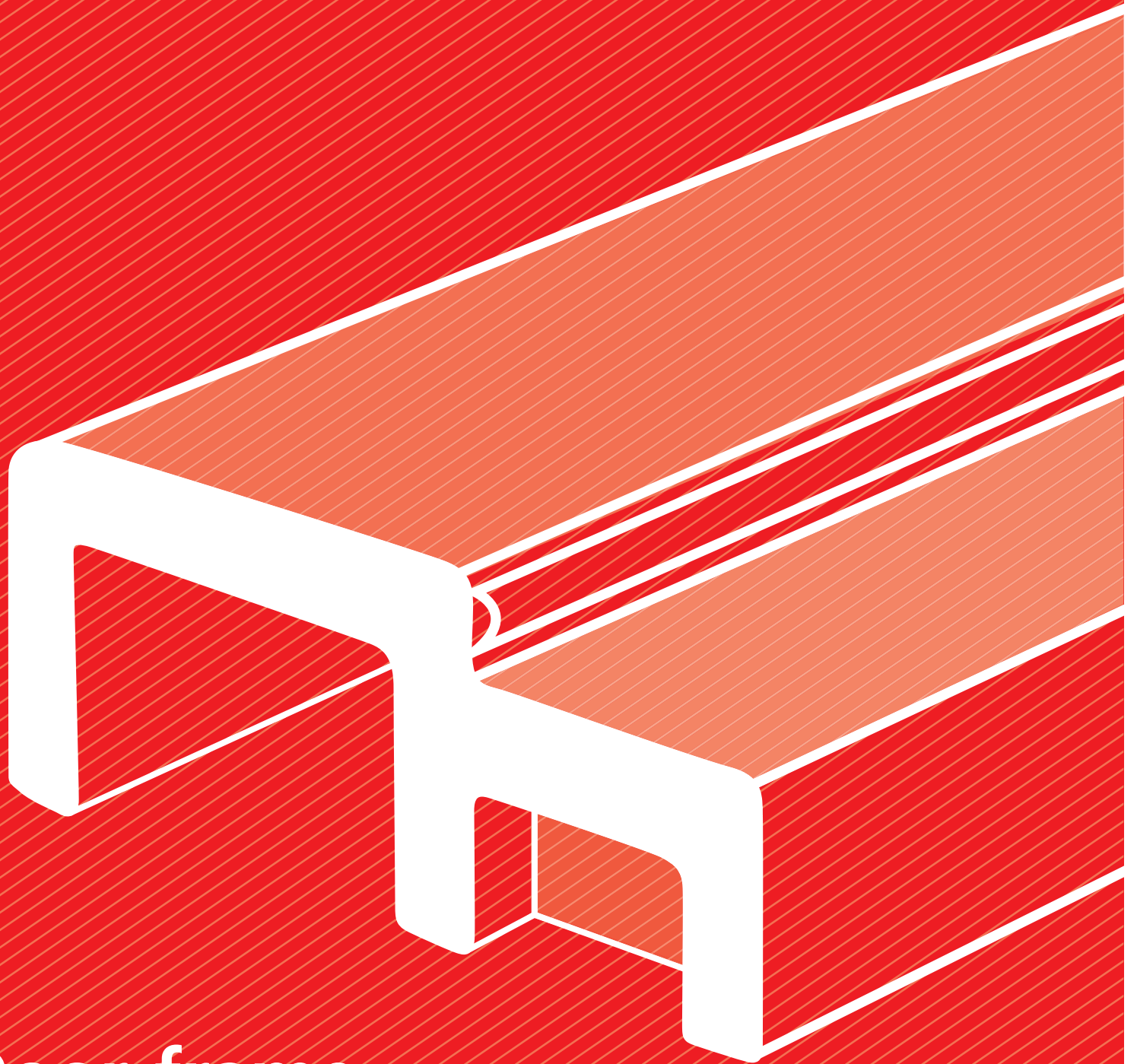

contents

■ Door frame	04
– Integral door frame / Gasket door frame / Ultra door frame	
■ ABS Door	08
■ Horizontal sliding door	14
■ Ternion interlocking Horizontal sliding door	18
■ Hardware Subsidiary	32
■ Steel reinforcement	34
■ Notification point	37
■ Ternion interlocking Horizontal sliding door specifications	38
■ Certificate verification	39



Door frame

- Integral door frame
- Gasket door frame
- Ultra door frame

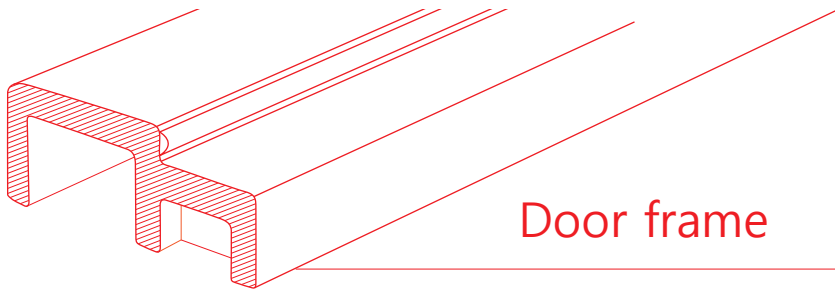

Door frame

◀ Door frame
KUMYOUNG Co., Ltd.

※ Actual product may vary from the image.

Integral door frame

| PVC-Special foam frame

- PVC foam frame is light and convenient for working
- PVC foam frame is very resistant to decay and moisture

| Steel reinforcement

- Using Steel-Plate reinforcement to Improve mechanical strength

| LVL- Reinforcement strip

- Improving hinge screw tightening force and door opening durability



110mm



130mm



140mm

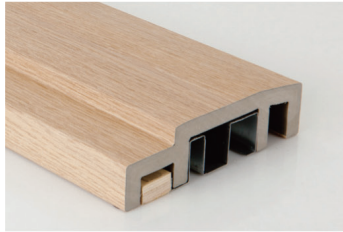

155mm



175mm



195mm



210mm



230mm



245mm

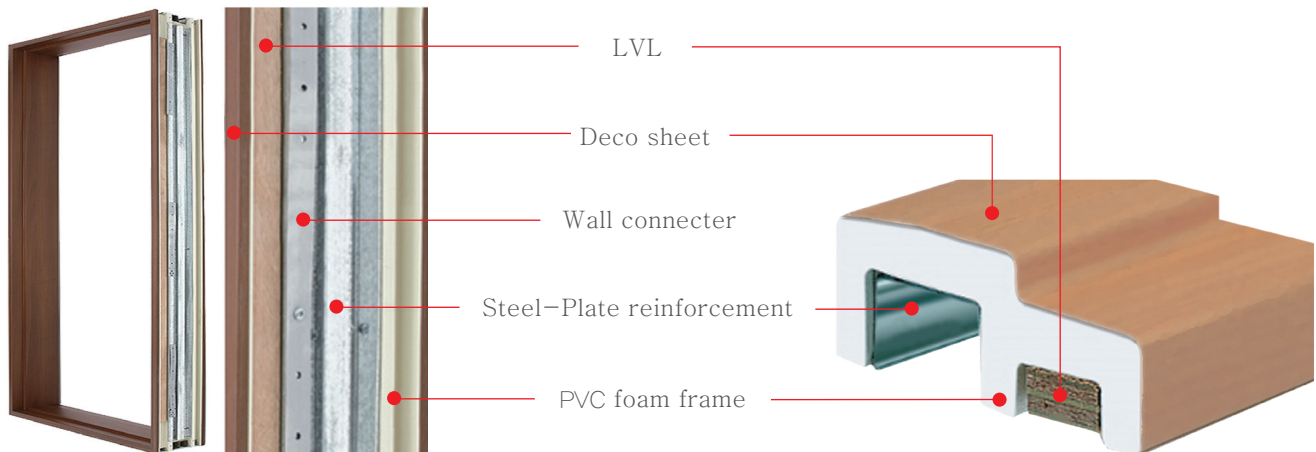

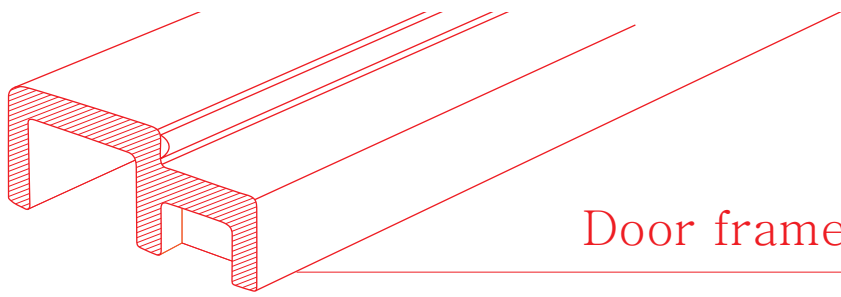

Door frame

Gasket door frame

| Gasket

- Improving the durability and workability by double extruded

| PVC-Special foam frame

- PVC foam frame is light and convenient for working
- PVC foam frame is very resistant to decay and moisture

| Steel reinforcement

- Using Steel-Plate reinforcement to Improve mechanical strength

| LVL- Reinforcement strip

- Improving hinge screw tightening force and door opening durability



110mm



130mm

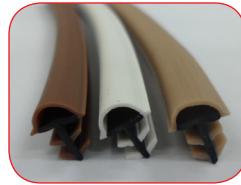

Gasket

Insertion direction

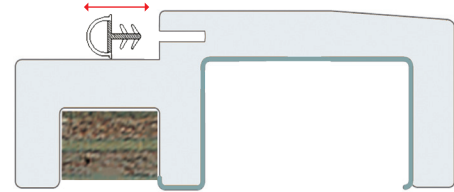

* Easy to change gasket



140mm



155mm



175mm



195mm

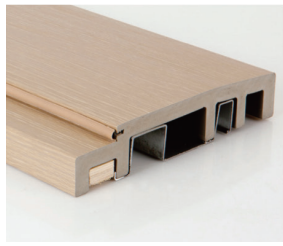

210mm

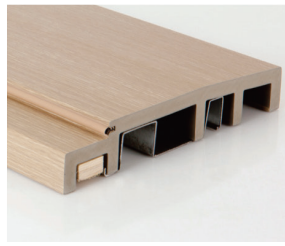

230mm

| The keynote of Gasket frame

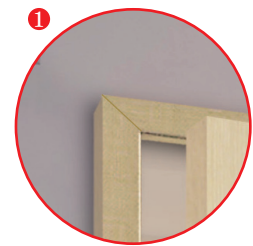

* 45° cutting and assembling

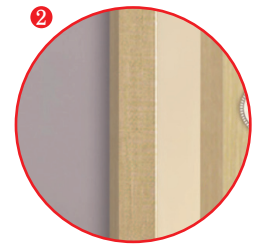

* Closing noise reduction, insulation and soundproof

※ Actual product may vary from the image.

Ultra door frame

- | Assemble stopper frame
 - Compensating for weak durability
- | PVC special foam frame
 - PVC foam frame is very resistant to decay and moisture
- | Steel reinforcement
 - Using Steel-Plate reinforcement to Improve mechanical strength
- | LVL- Reinforcement strip
 - Improving hinge screw tightening force and door opening durability



135mm



155mm



175mm



195mm



210mm



225mm

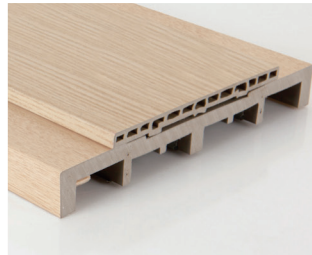

240mm



250mm

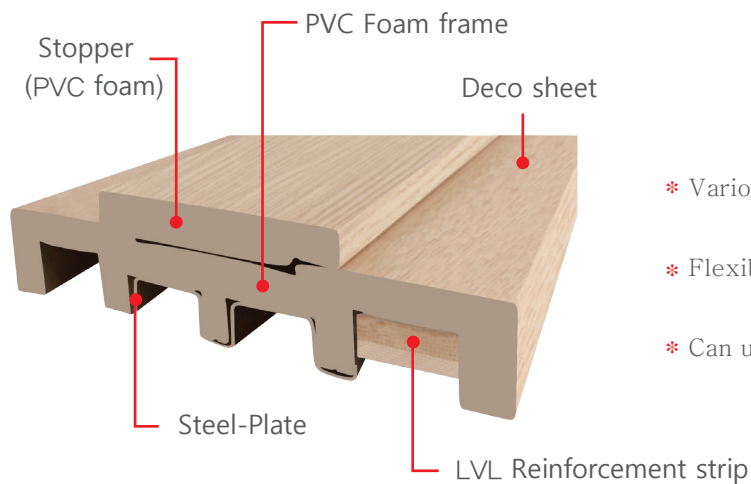

- * Various construction method
- * Flexible stopper
- * Can use many size of door

KUMYONHG Co., Ltd.

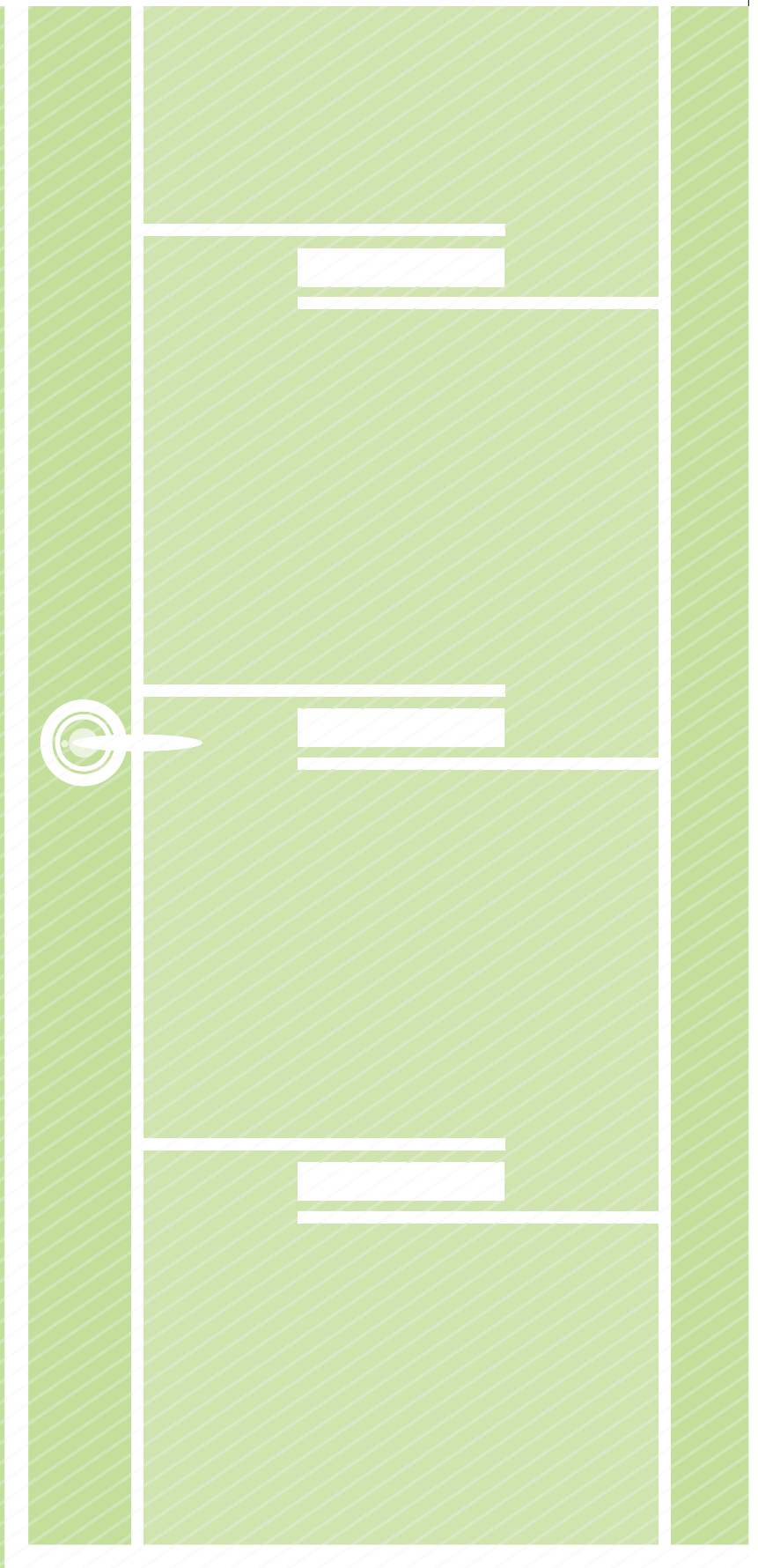

ABS Door

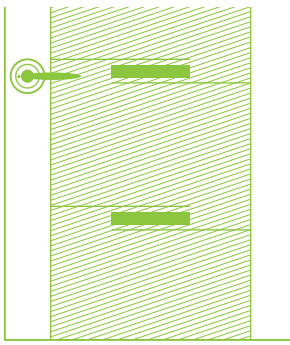

ABS Door

◀ ABS Door
KUMYOUNG Co., Ltd.

※ Actual product may vary from the image.

| Various designs and good processability, easy installation

- Various patterns ABS Sheet, Various colors of the decor sheet option
- Using PVC foam LVL, excellent processability
- Using Honey-comb filling the board to reduce weight, Soundproofing and insulation

| Periodic quality management

- Managing scans performed using an KUMYOUNG quality control system
- Continuous quality improvement practices

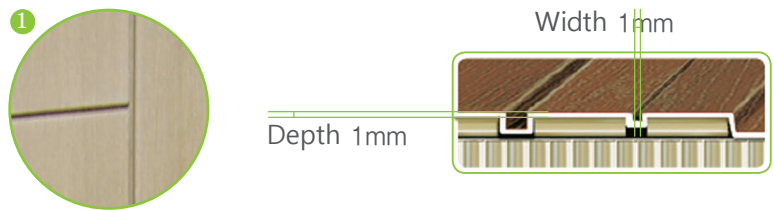

- ※ Can produce fine and delicate expression by using ABS Sheet
- ※ Using advanced design and deco sheet

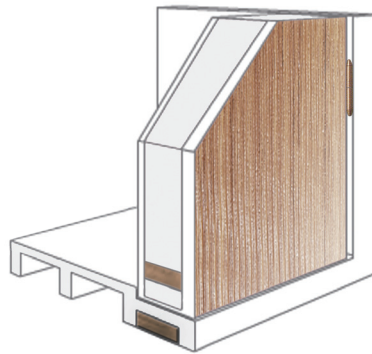

- ※ Easy to cutting PVC foam LVL
- ※ Soundproofing and insulation by honey-comb board
- ※ Avoid bending and distortion

| ABS door Configure cross-section

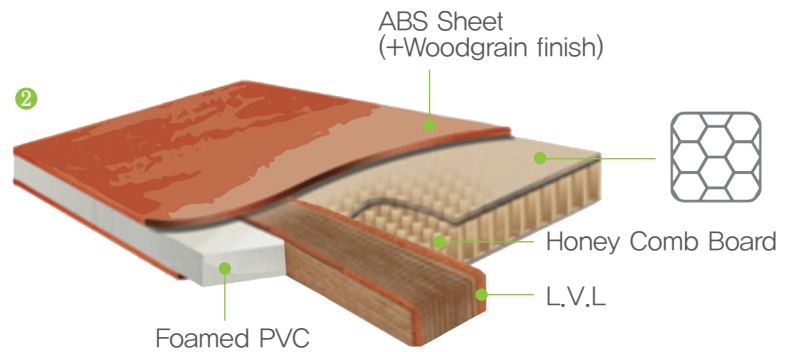

※ ABS doors exist max,minimum size so please contact us when you need doors

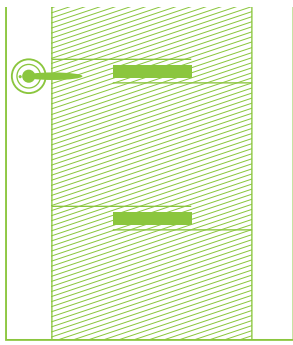

ABS Door



KYD_01



KYD_02



KYD_03



KYD_04



KYD_05



KYD_06

※ Actual product may vary from the image.



KYD_07



KYD_08



KYD_09



KYD_10



KYD_11



KYD_12

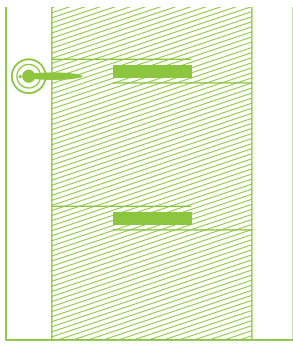

ABS Door

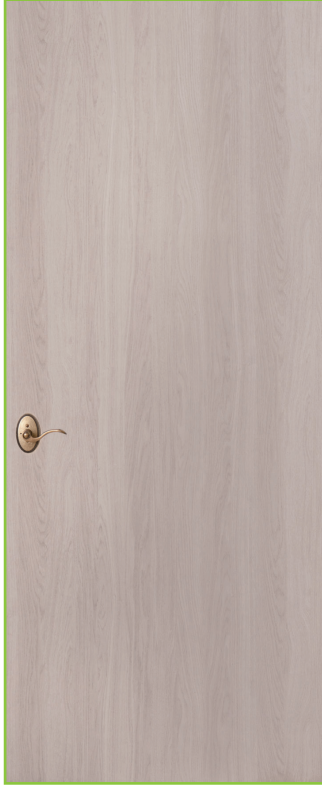

KYD_13



KYD_14



KYD_15

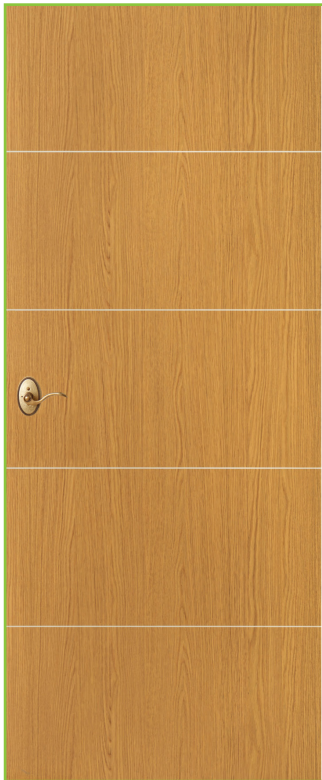

KYD_16



KYD_17



KYD_18

※ Actual product may vary from the image.



KYD_19



KYD_20



KYD_21



KGD_01



KGD_02

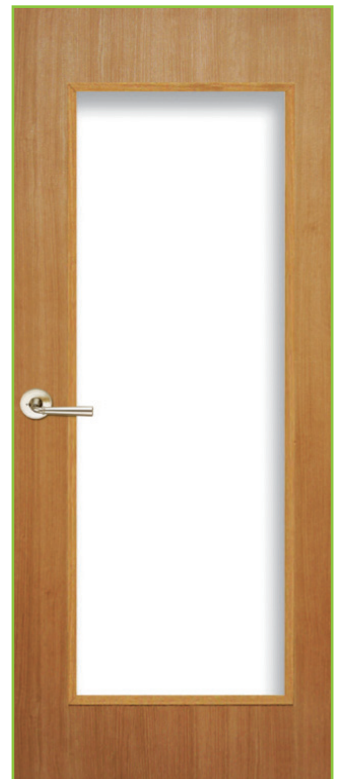

KGD_03

KUMYOUNG Co., Ltd.

Horizontal sliding door

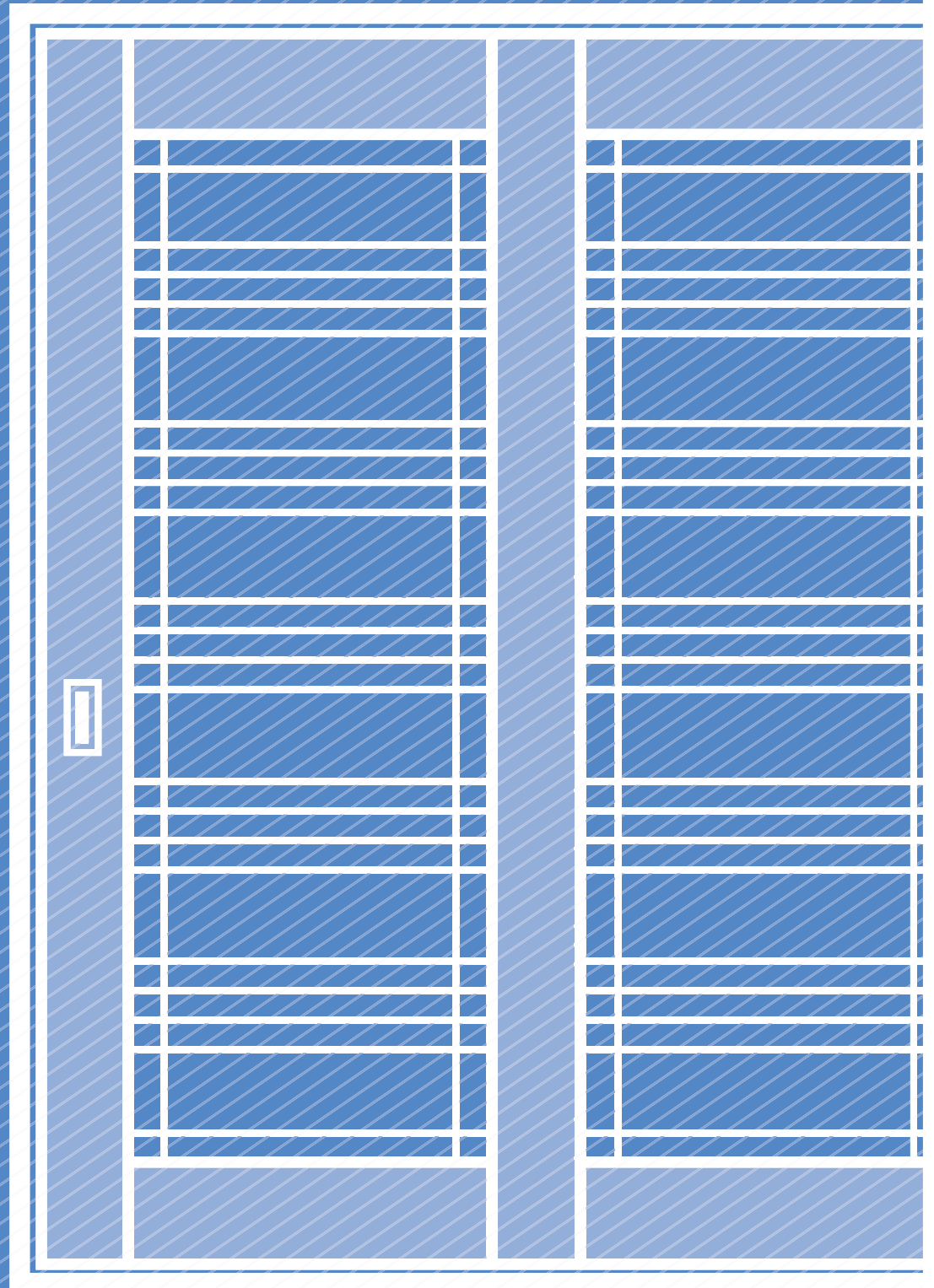

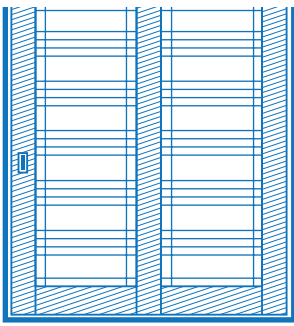

Horizontal sliding door

Horizontal sliding door
KUMYOUNG Co., Ltd.

※ Actual product may vary from the image.

- | Insert the reinforcement steel-plate structure, increase product durability
- | Easy-to-use assembly bead to the assembly, knife block construction is possible
- | 45° assembly, minimize twisting
- | PVC foam frame is very resistant to decay and moisture

→ 45° assembly

		
120 Frame	Horizontal bar	Vertical bar
		
Jam cap	Rail	Middle bar
		
5mm bead	Assembly bead	Fixed Bar

120 1 hole sliding door

		
Up side	Rail	Rail assembly
		
Down side	Door roller	Jamcap Assembly

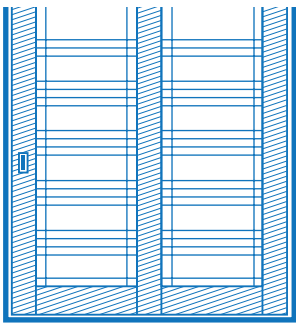

Horizontal sliding door

1 hole Horizontal sliding door

| Basic I



| Basic 1 hole Horizontal sliding door

- Living room, kitchen, porch and living room separated by a family atmosphere changes
- Reduce smells spread, reduce the warmth of cold air outgoing
- Can produce a variety of glass designs, deco sheet



| Basic II



| Basic 5 hole Horizontal sliding door

- original sliding door, simple design
- High structural strength

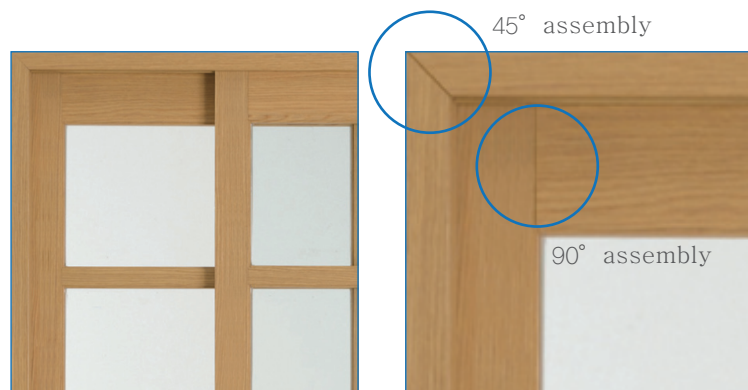

※ Actual product may vary from the image.

1 hole Horizontal sliding door

- 1 hole Horizontal sliding door is made by many type of glass



Color_US201

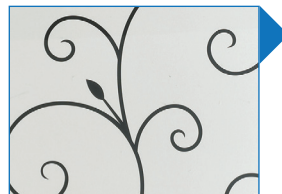

Color_FZ805

ETC.

- 2,3,4 hole Horizontal sliding doors



5 hole 1 block

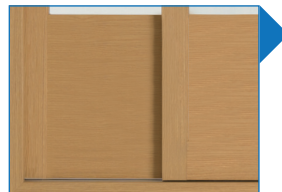
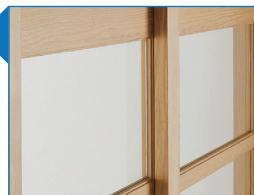

2 hole 1 block



**Ternion
interlocking
Horizontal
sliding door**



Ternion interlocking sliding door

◀ Ternion door
KUMYOUNG Co., Ltd.

※ Actual product may vary from the image.

- | Insert the reinforcement steel-plate structure, increase product durability
- | Easy-to-use assembly bead to the assembly, knife block construction is possible
- | 45° assembly, minimize twisting
- | PVC foam frame is very resistant to decay and moisture

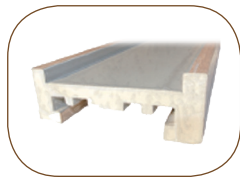

140 Frame



Vertical Jamcap



Up side jamcap

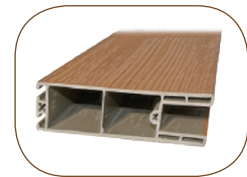

Horizontal bar



Vertical bar



Steel-plate



Down side



Door roller

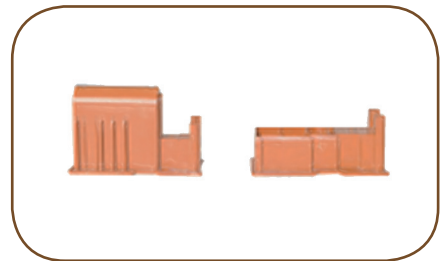

PVC Cap

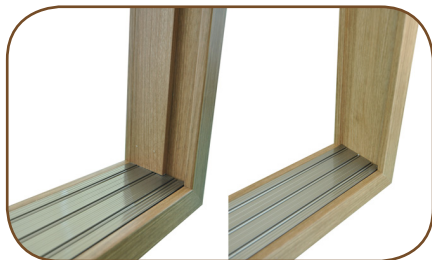

Vertical side

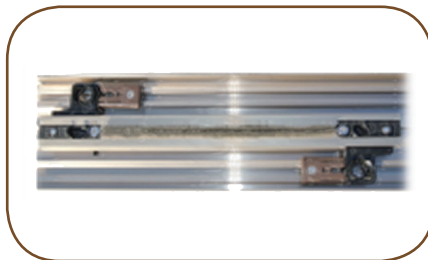

Hardware



Assembly bead



Ternion interlocking sliding door

UV Printing

| Various designs, gradation



Spring



Paradise



Hollyhock

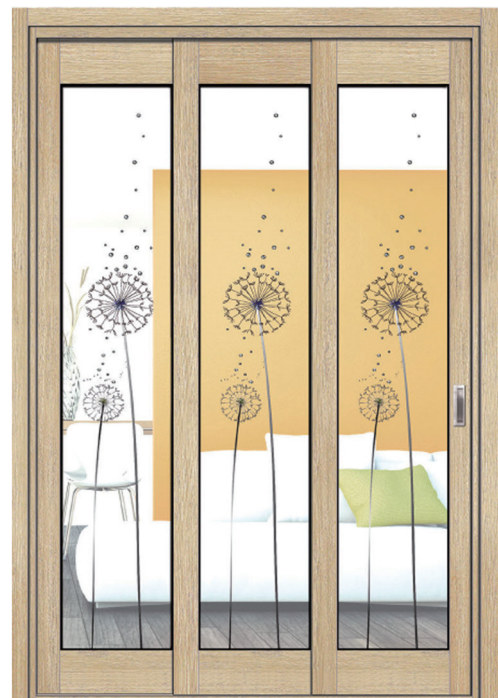

Symphony

※ Actual product may vary from the image.

UV Printing

| Various designs, gradation



Utopia

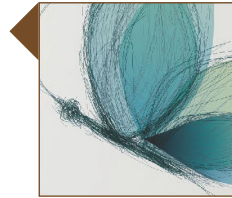

Summer



Finland



Cosmos



Ternion interlocking sliding door

Beads Glass

| Various designs, gradation



Style



Camellia



Kansone



Mico(BS)

※ Actual product may vary from the image.

Beads Glass

| Various designs, gradation



Basel (BS)

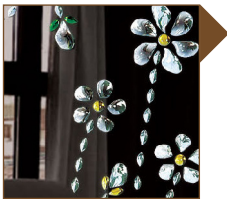

Margaret



Odessa

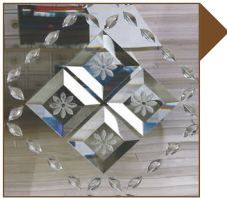

Fermat



Ternion interlocking sliding door

Safety Nature

| Various designs, gradation



Passion



Ludia



Vanilla

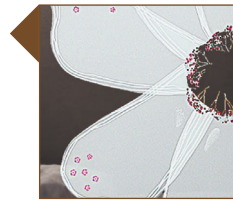

Blossom of snow

※ Actual product may vary from the image.

Safety Nature

| Various designs, gradation

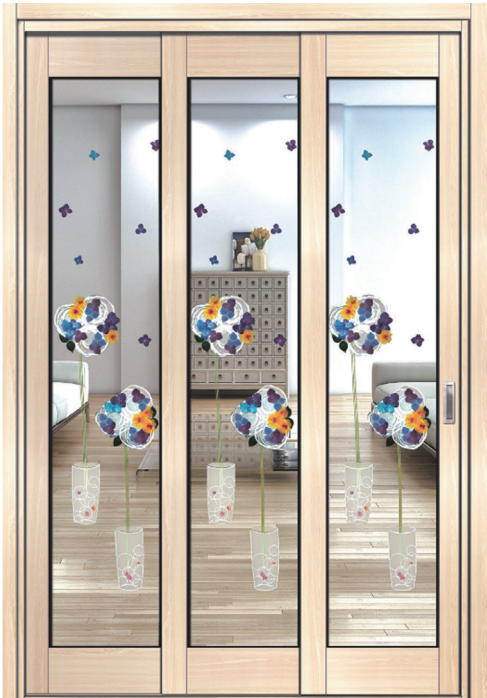

Topiary

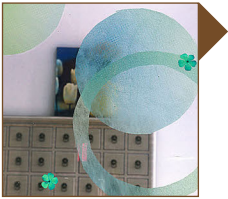

Seattle



Magic (M-cutting)

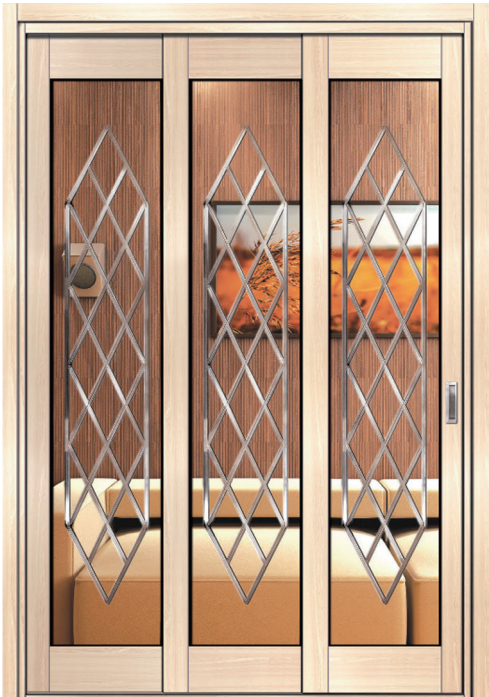
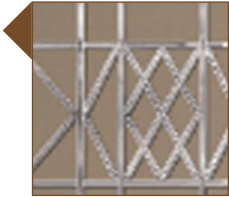

Chaos(W-cutting)



Ternion interlocking sliding door

Fogging

| Various designs, gradation



Beech

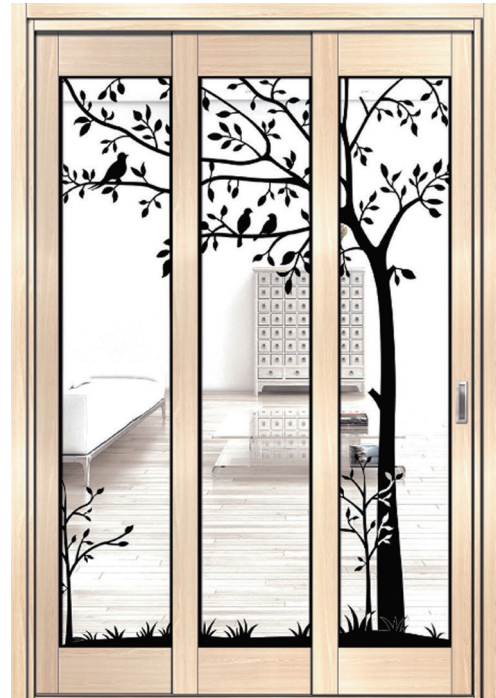

Janus



Thorn tree

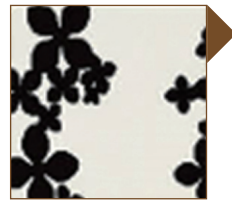

Ivy

※ Actual product may vary from the image.

Fogging

| Various designs, gradation



Classic



Baroque



Melody



Baekyang Flowers



Ternion interlocking sliding door

Classic Fogging

| Simple Luxury fogging, Using HDF.



CD008



CD009



CD010



CD011



CD012



CD014



CD016



CD017



CD018



CD021



CD022



CD023



CD024



CD027



CD038



CD039



CD040



CD046



CD051



CD052



CD053



CD054



CD055



CD056



CD057



CD058



CD059

※ Actual product may vary from the image.

Classic Fogging

| Simple Luxury fogging, Using HDF.



CD060



CD062



CD063



CD067



CD068



CD070



CD073



CD074



CD075



MMC-B



SLD-B



SSLA-B



LYL-B



BYOL-B



JMS-B



AMS-B



SLA-B



LJT-B



CD088



CD089



CD001



CD002



CD003



CD004



CD098



CD100



CD102



Ternion interlocking sliding door

Horizontal sliding door materials list

- | Insert the reinforcement steel-plate structure, increase product durability
- | Easy-to-use assembly bead to the assembly, knife block construction is possible
- | This materials can compatible with all kinds of KUMYOUNG sliding door
- | PVC foam frame is very resistant to decay and moisture



140mm Fream-A



120mm Fream



140mm Fream-B



Horizontal bar

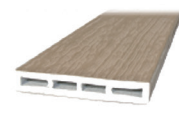

Vertical jamcap

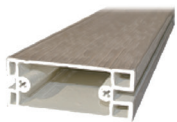

Middle bar



Vertical bar-A



Vertical bar-B

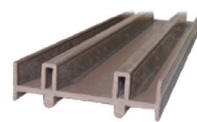

Rail



Vertical steel plate

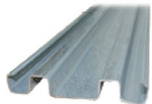

120mm Fream steel plate

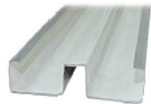

140mm Fream steel plate



Upside jamcap



Jamcap

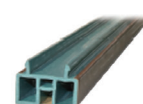

5mm bead



Fixed Bar

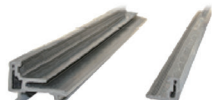

Assembly bead

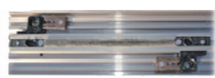

Hardware



Door roller



PVC cap_a



PVC cap_b



PVC cap_3

Hardware Subsidiary

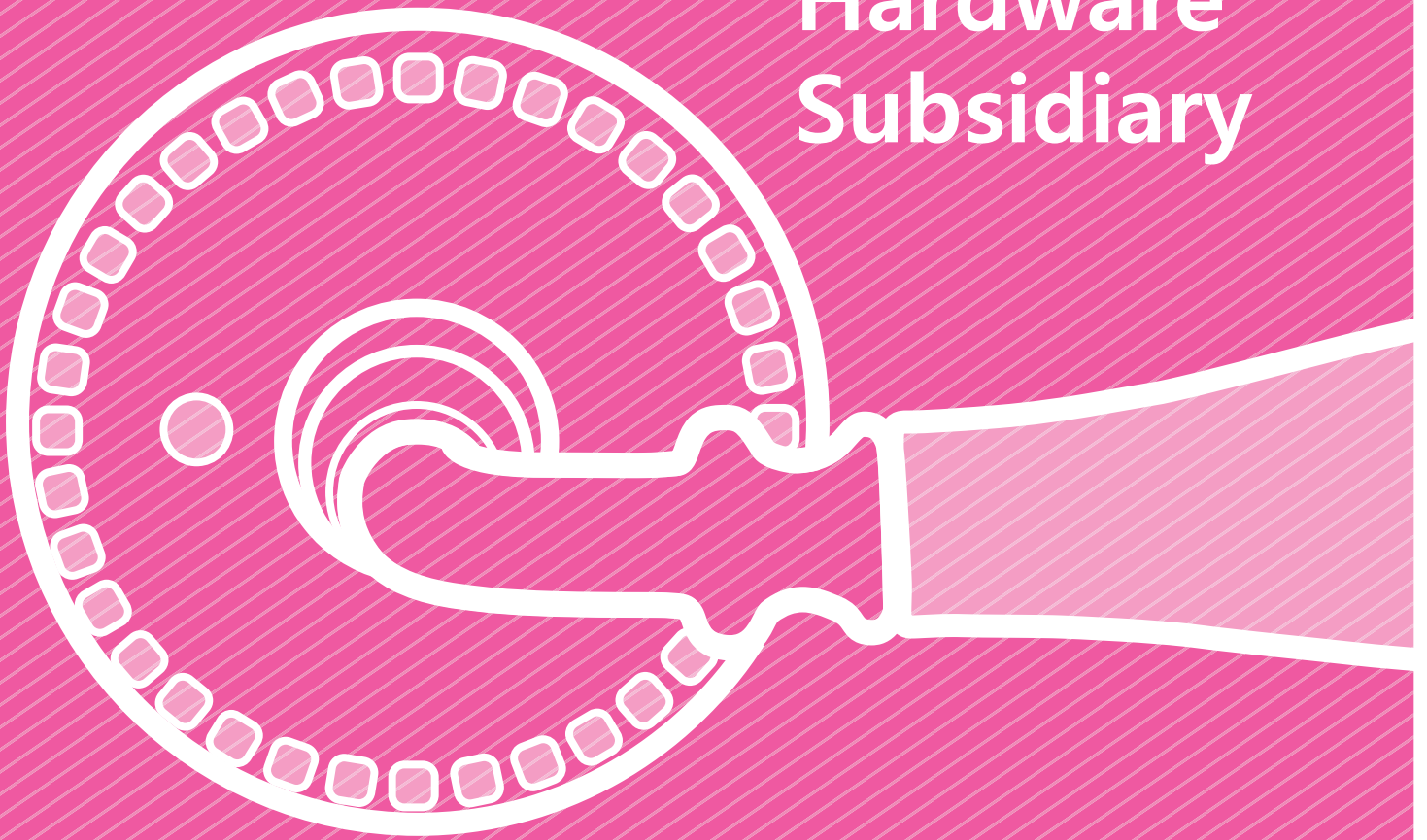

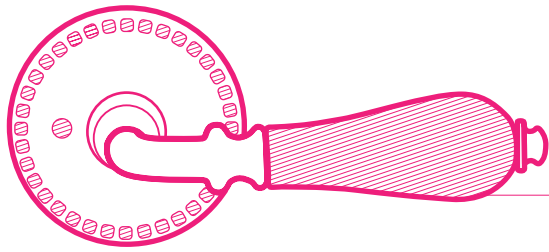

※ Actual product may vary from the image.

도어 손잡이 & 경첩

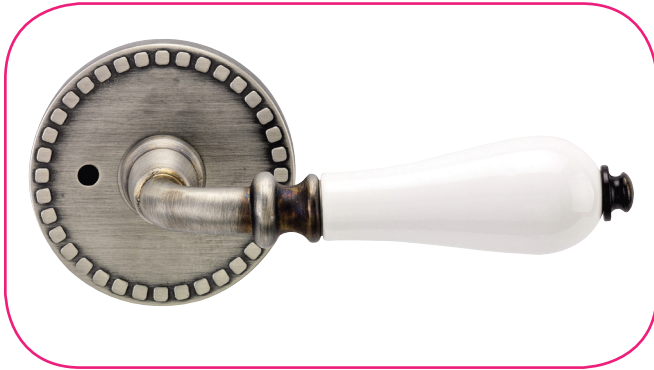

New art

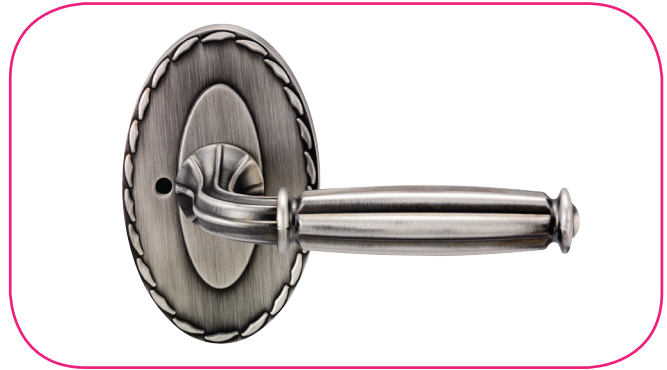

Bella



Bullet

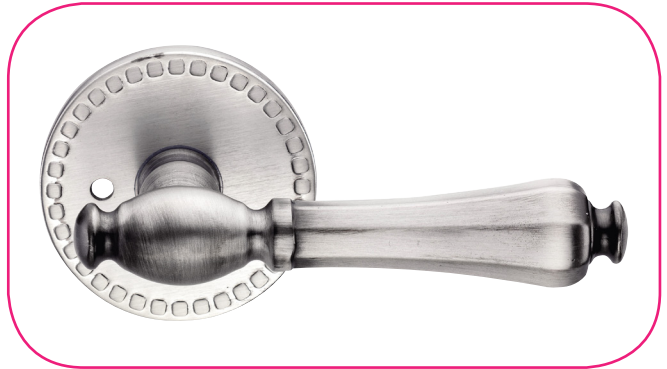

Odin



Flower



Sense



SBG 4035



VNG 4035

KUMYOUNG Co., Ltd.

Steel reinforcement



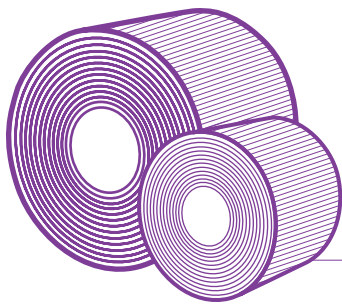

Windows and Doors

◀ Steel reinforcement
KUMYOUNG Co., Ltd.

※ Actual product may vary from the image.

- | Various steel plate reinforcement
 - PVC products combine with steel plate to reinforce
 - Steel plate can make PVC products hold much weight

- | Corrugated steel sheet
 - We can handle many kinds of steel coil (GI,CR, EGI, HGI etc.) , (0.4T~3.0T)
 - Pallet restrictions apply frame, lightweight steel, cable trays, ducts, automotive frames and various roll forming products

| Windows

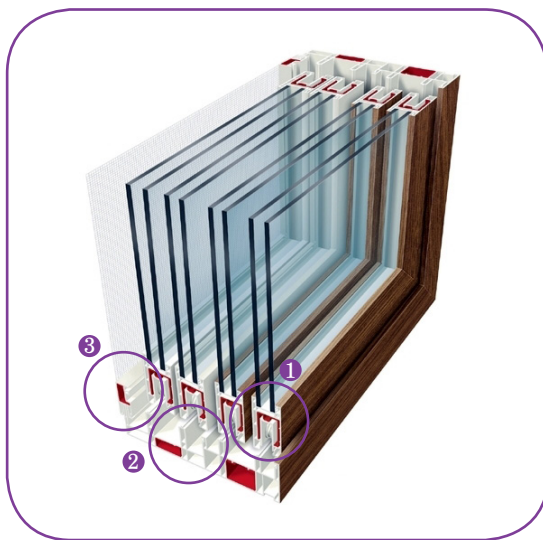

Window assembly

① SF steel plate

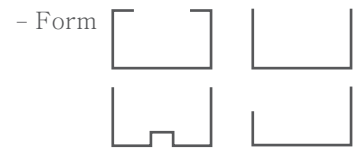

② BI steel plate



③ MF steel plate

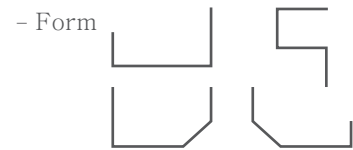

Project Window

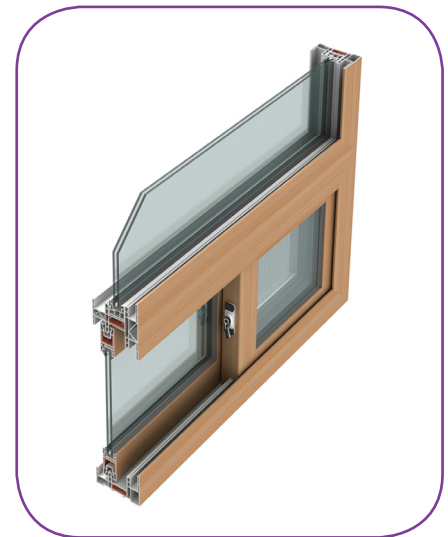
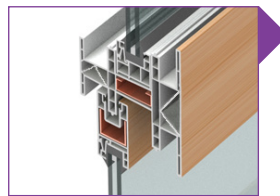

Schools window



* If you need order kinds of steel products, please call us.

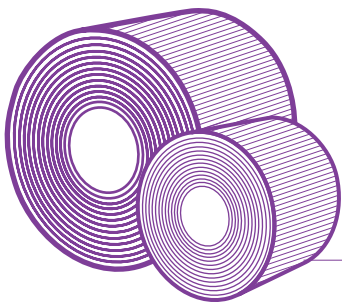

Windows and Doors

◀ Steel reinforcement
KUMYOUNG Co., Ltd.

※ Actual product may vary from the image.

| Door steel plate form

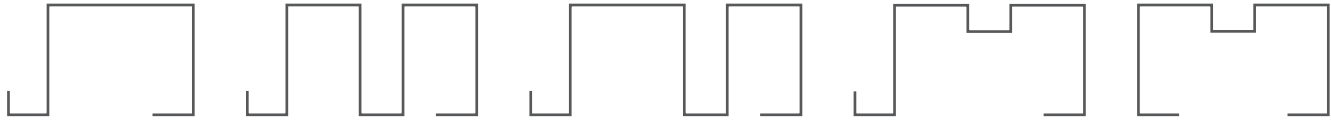

* We can make order products please call us.

| Pallet restrictions apply frame

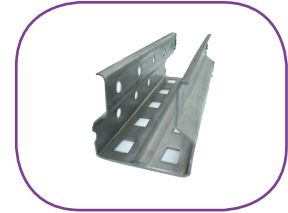
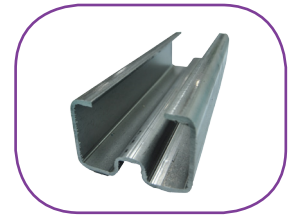
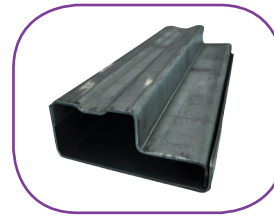

| House pad (holding vinyl)

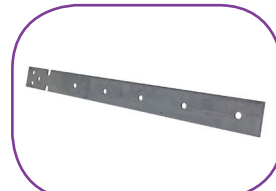

230mm flat iron

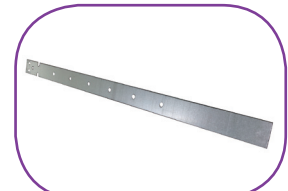

350mm flat iron

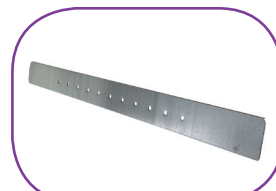

350mm 0.8t flat iron

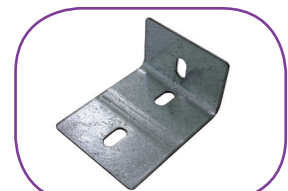

'ㄱ' flat iron

↓ Assembly house pad

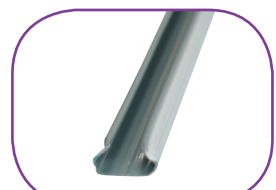
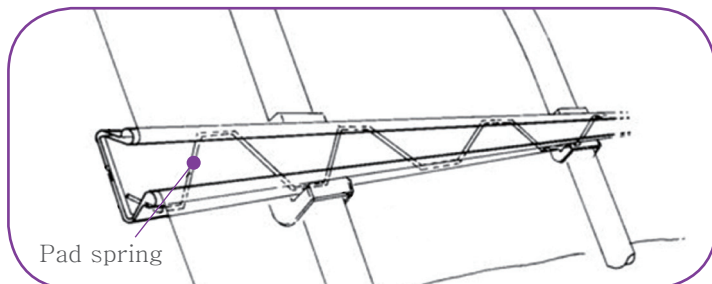

House pad

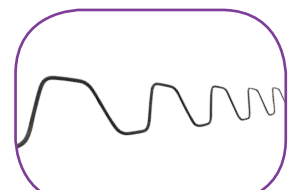

Pad spring



Notification point

◀ Notification point
KUMYOUNG Co., Ltd.

| Notification point about door frame



1. Holding frame

* The door frame trim before fixed



2. Fixing frame

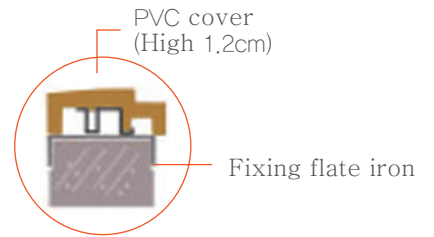

3. Filling around the door frame



4. Molding attaching

Molding



5. Covering

PVC Cover High over 1.2mm

| directions for the use of PVC products



Flammables



Care scratch

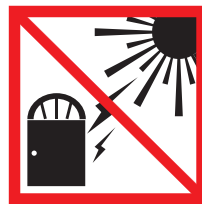

Care sunlight



Care high temperature



Using only in side



Don't change structure



Remove the protective film



Shock attention

Ternion interlocking Horizontal sliding door specifications

1. Assembly door frame

- 45 ° Assembly door frame

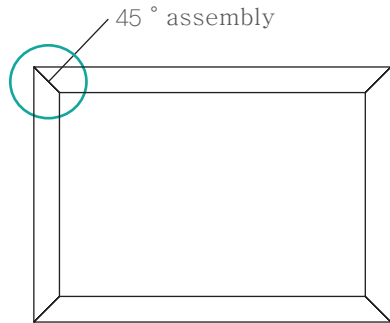

2. Fixed door frame

- Check Vertical, horizontal and hold
- Fixing minimum 6 points by Fixing type A,B

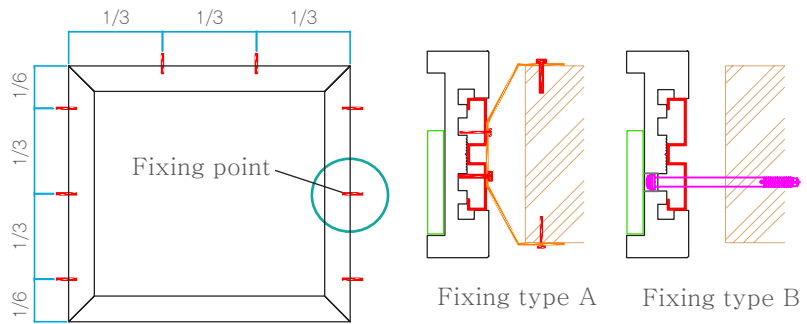

3. Filling around the door frame

- Filling mortar, urethane around the frame

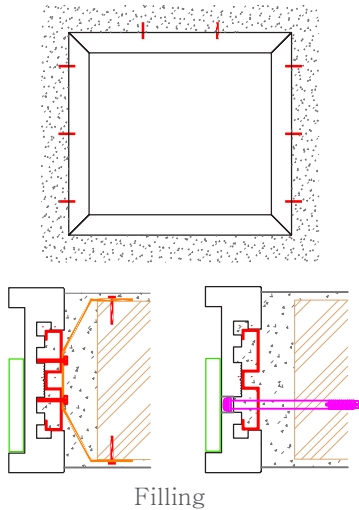

4. Cover door frame

- Covering by PVC cover
- High over 1,2 M
- Covering down side of frame
- Remove the cover when use it

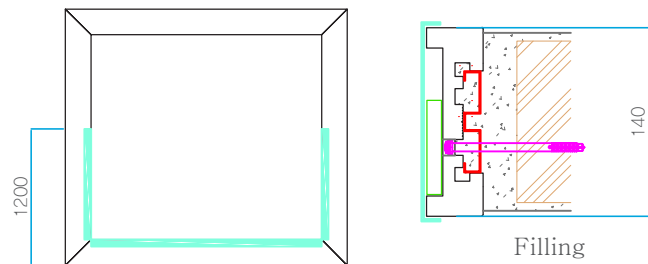

5. Filling around the door frame

- Measured after door production
- Top hardware, lower hardware attached
- Door installation
- Attach the upside jamcap

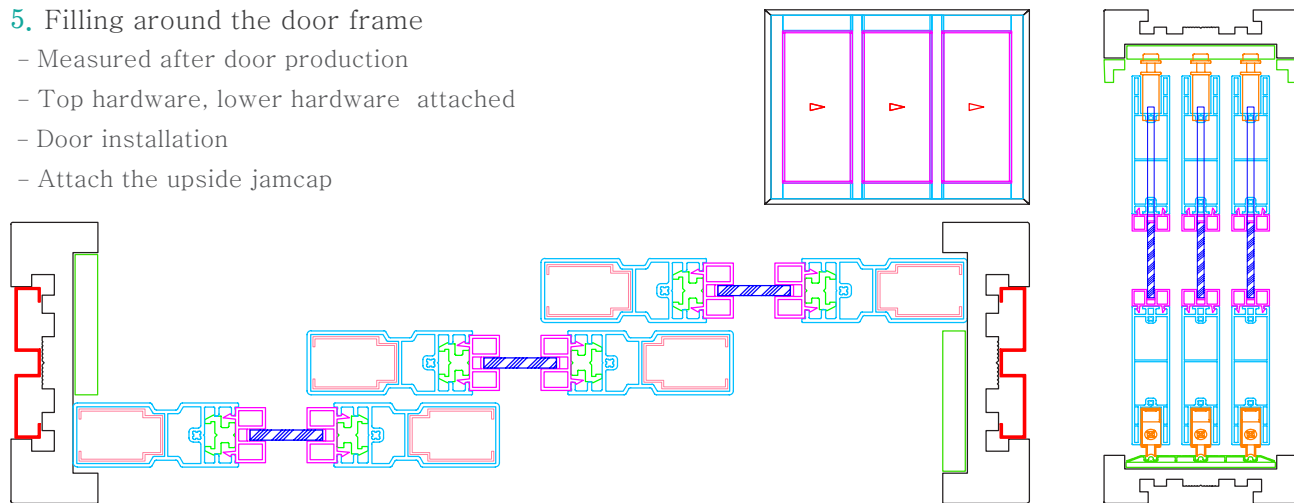

* Fixed with glue, silicone or Taka to construction.